



# KRUPP

**130 ton Capacity  
All-Terrain-Crane**



# KMK 5130



# Dimensions

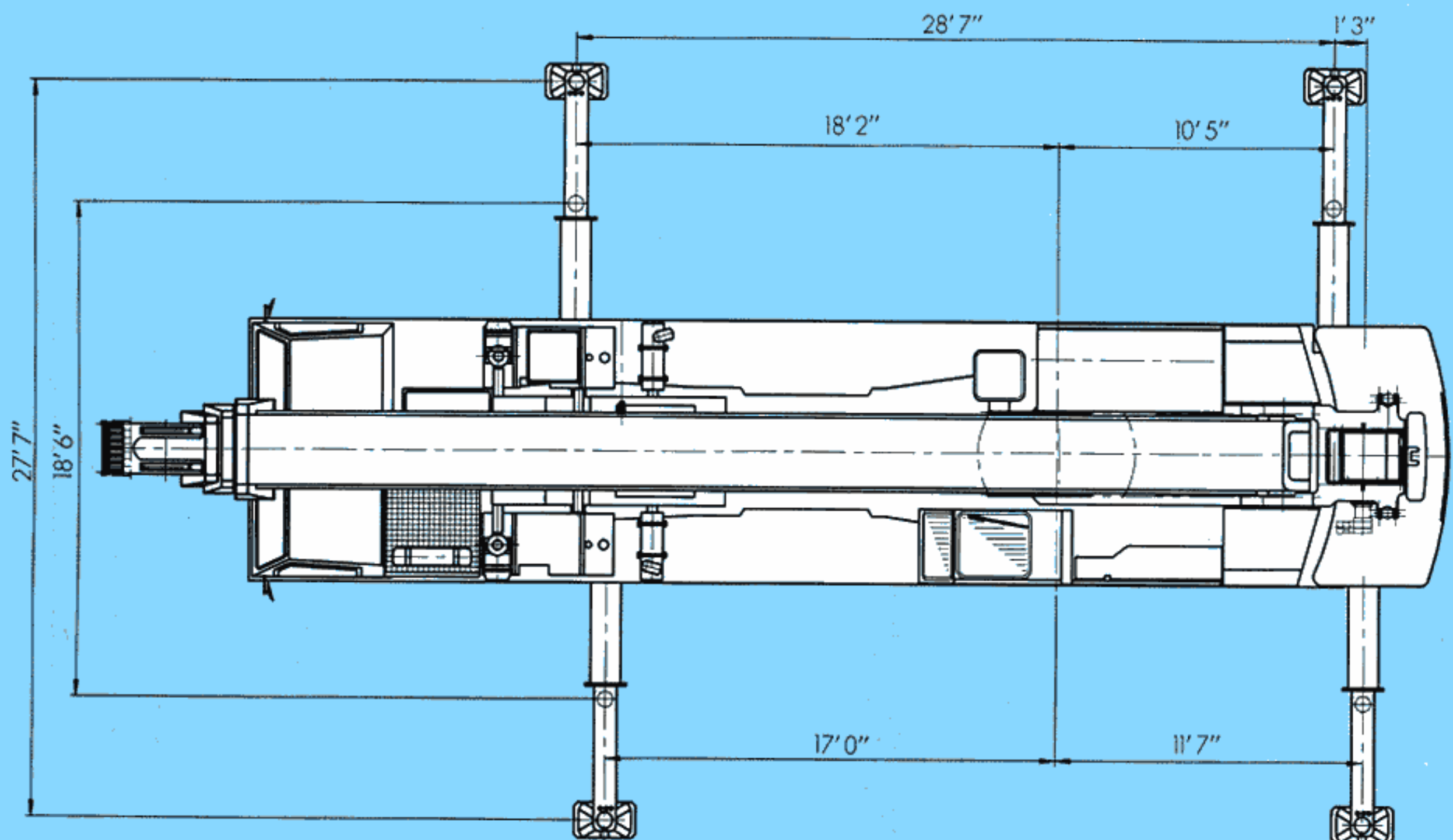
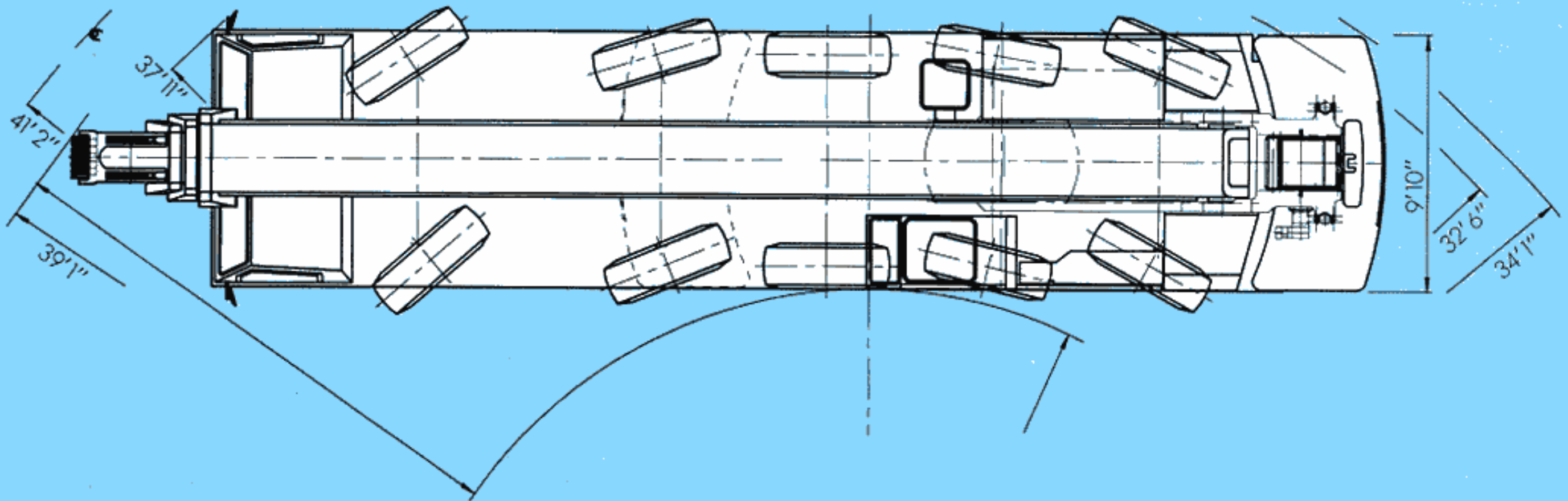
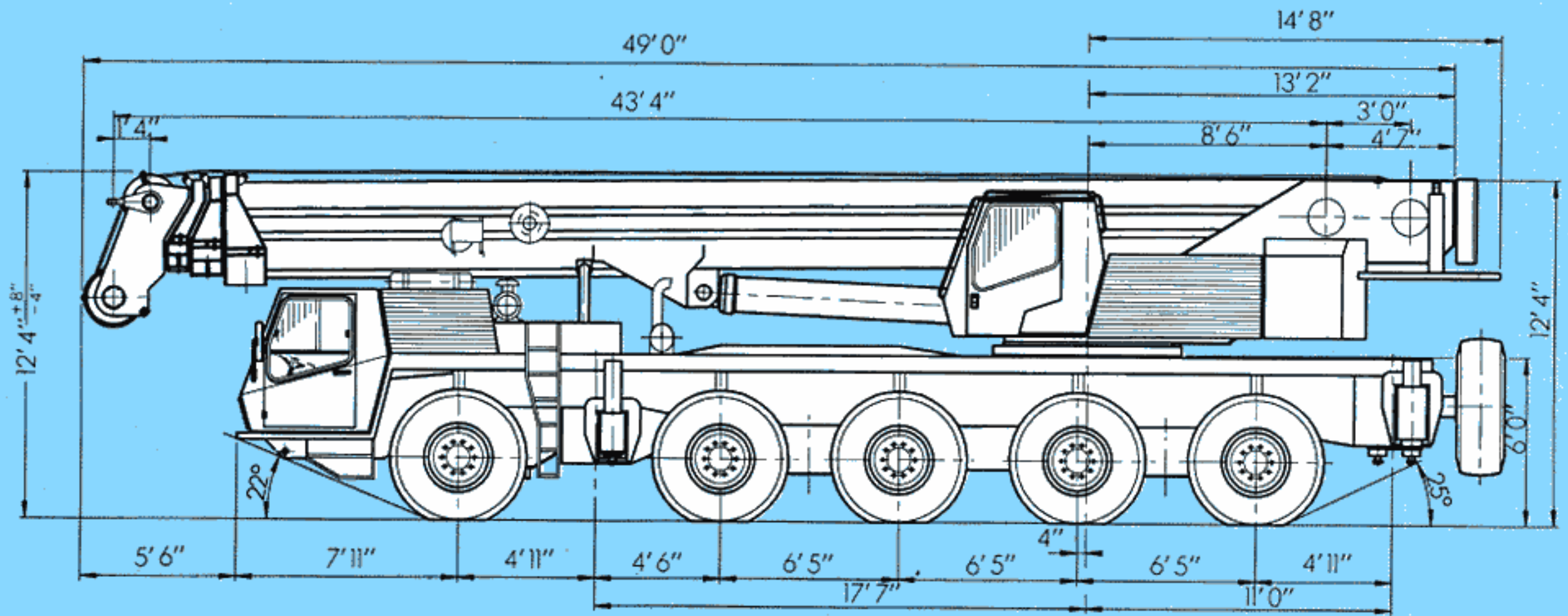



# Hook elevation diagram

Main boom and lattice extension

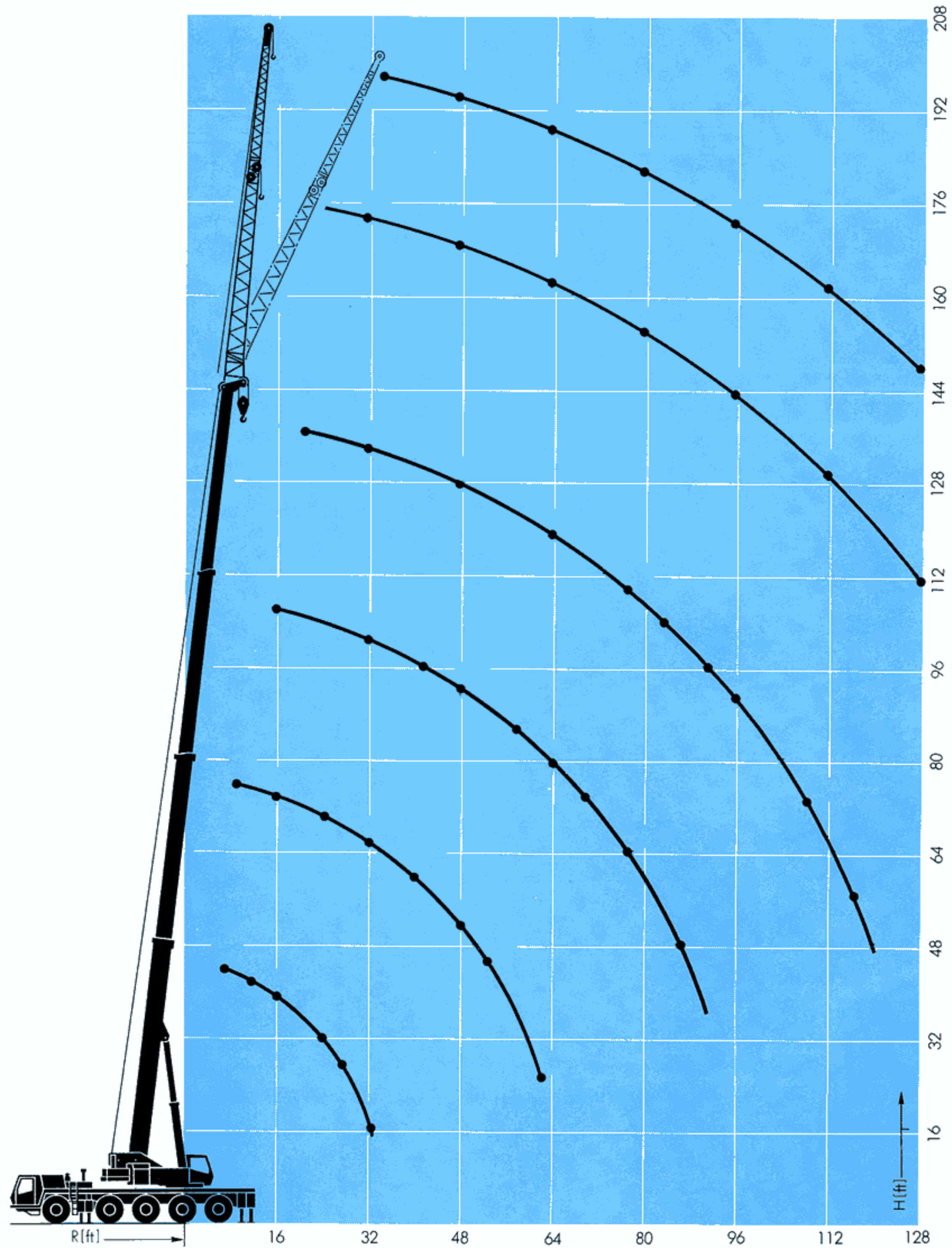

# Lifting capacities in 1000 lbs

Main boom



43 – 139 ft



360°

35,3 \*

Counterweight lbs

Radius ft	43 ft*	43 ft	75 ft		91 ft	107 ft		129 ft	139 ft	Radius ft	
10**	260.0									10**	
10	240.8	223.1	140.0	84.8						10	
11	230.0	212.4	140.0	84.8						11	
12	219.6	202.3	140.0	84.8						12	
13	209.5	193.0	140.0	84.8						13	
14	190.6	183.0	140.0	84.8	104.2					14	
15	173.0	173.0	139.2	84.8	104.2					15	
20	134.0	134.0	117.6	79.3	101.4	84.4	43.8			20	
25	108.3	108.3	99.8	69.2	89.0	77.4	43.8	52.7	39.9	25	
30	86.9	86.9	86.0	61.6	79.0	69.5	43.8	52.4	39.9	30	
35			71.1	55.5	68.7	62.7	42.8	49.3	39.9	35	
40			56.0	50.3	57.6	56.2	39.2	46.6	39.9	40	
45			45.3	46.1	46.6	48.9	35.9	42.2	39.9	45	
50			37.1	42.3	38.4	40.7	33.3	39.2	38.5	50	
55			31.1	37.6	32.2	34.5	30.7	35.5	34.9	55	
60					27.0	29.4	28.4	30.9	30.7	60	
65					22.7	25.2	26.2	26.5	26.5	65	
70					19.1	21.6	24.6	23.2	23.2	70	
75					15.9	18.4	22.8	20.1	20.1	75	
80						15.7	20.5	17.2	17.2	80	
85						13.3	18.2	14.9	14.9	85	
90						11.3	16.1	12.8	12.8	90	
95								11.0	11.0	95	
100								9.4	9.4	100	
105								7.9	7.9	105	
110								6.5	6.5	110	
115									5.4	115	
	T1	0	0	1	0	1	1	0	0.9	1	T1
	T2	0	0	0	0.5	0.5	0.5	1	0.9	1	T2
	T3	0	0	0	0.5	0	0.5	1	0.9	1	T3

\* ±10° over rear

\*\* represents test load

\*1000 lbs

## Notes for lifting capacities

Load capacities above bold line are based on structural strength, and tipping must not be relied upon as a limitation of lifting capacity.

Rated loads must not be exceeded.

Rated loads do not exceed 85% of tipping load with the machine properly levelled on firm ground.

360° duties – on outriggers fully extended.

Note counterweight required as listed in relevant lifting capacity columns.

For safe crane operation due allowance must be made to compensate for high winds, side load, pendulum action and other hazardous conditions. No side pull permitted.

Hook blocks, slings and /or boom attachments are considered part of load, and their weight must be deducted from the rated lifting capacity to determine the net load.

Boom must be extended in accordance with sequence as noted on lifting capacity chart.

Consult crane manual to determine weight reduction for load handling devices and boom attachments.

Operate crane strictly in compliance with operator's manual.



# Lifting capacities in 1000 lbs

Main boom



43 - 139 ft



360°

17,6 \*

Counterweight lbs

Radius ft	43 ft	75 ft		91 ft	107 ft		129 ft	139 ft	Radius ft	
10	202.3	127.8	77.1						10	
11	192.2	127.8	77.1						11	
12	182.1	127.8	77.1						12	
13	172.1	127.8	77.1						13	
14	162.6	127.8	77.1	94.8					14	
15	153.2	127.0	77.1	94.8					15	
20	118.5	107.0	72.1	92.3	76.8	39.9			20	
25	94.7	89.9	63.0	81.0	70.4	39.9	52.5	39.9	25	
30	74.0	69.0	56.1	67.0	63.1	39.9	48.7	39.9	30	
35		52.4	50.5	52.7	53.2	39.0	44.9	39.9	35	
40		40.5	45.5	41.8	43.2	35.7	41.2	39.4	40	
45		32.0	38.7	33.3	35.2	32.7	35.2	34.2	45	
50		25.3	32.1	26.6	28.9	30.2	29.4	28.5	50	
55		20.2	27.0	21.5	23.9	27.4	24.8	24.2	55	
60				17.2	19.6	24.0	21.0	20.3	60	
65				13.6	16.0	20.7	17.6	17.3	65	
70				10.8	13.3	17.9	14.8	14.6	70	
75				8.5	10.9	15.5	12.4	12.2	75	
80					8.8	13.4	10.3	10.1	80	
85					6.9	11.5	8.4	8.4	85	
90					5.4	10.0	6.9	6.9	90	
95							5.5	5.5	95	
100							4.3	4.3	100	
105							3.3	3.3	105	
110							2.3	2.3	110	
115									115	
	T1	0	1	0	1	1	0	0.9	1	T1
	T2	0	0	0.5	0.5	0.5	1	0.9	1	T2
	T3	0	0	0.5	0	0.5	1	0.9	1	T3

\*1000 lbs



43 - 139 ft



360°

6,6 \*

Counterweight lbs

Radius ft	43 ft	75 ft		91 ft	107 ft		129 ft	139 ft	Radius ft	
10	201.1	127.8	77.1						10	
11	190.3	127.8	77.1						11	
12	179.6	127.8	77.1						12	
13	168.8	127.8	77.1						13	
14	158.1	127.8	77.1	94.8					14	
15	148.3	127.0	77.1	94.8					15	
20	114.1	106.5	72.1	92.3	76.8	39.9			20	
25	89.6	80.9	63.0	76.5	70.4	39.9	52.5	39.9	25	
30	64.8	59.5	56.1	57.6	57.7	39.9	48.7	39.9	30	
35		45.1	50.5	44.0	45.0	39.0	43.2	39.9	35	
40		33.9	41.4	34.2	35.4	35.7	35.0	34.0	40	
45		25.7	33.0	26.9	28.5	32.7	28.6	27.7	45	
50		19.7	26.7	21.2	23.1	28.3	23.5	22.9	50	
55		15.1	22.2	16.5	18.9	23.7	19.6	18.9	55	
60				12.6	15.0	19.9	16.2	15.5	60	
65				9.6	12.0	16.9	13.5	12.9	65	
70				7.2	9.6	14.3	11.1	10.6	70	
75				5.1	7.4	12.0	9.0	8.7	75	
80					5.5	10.2	7.1	7.0	80	
85					4.0	8.6	5.6	5.4	85	
90					2.7	7.3	4.2	4.0	90	
95							3.0	2.9	95	
100									100	
105									105	
110									110	
115									115	
	T1	0	1	0	1	1	0	0.9	1	T1
	T2	0	0	0.5	0.5	0.5	1	0.9	1	T2
	T3	0	0	0.5	0	0.5	1	0.9	1	T3

\*1000 lbs



# Lifting capacities in 1000 lbs

Main boom + swing-away extension



38 and 62 ft



360°



Counterweight 35,3 lbs

Radius ft	Boom length (ft) + lattice extension length (ft)								Radius ft
	91.0 ft 38.0 ft		107.0 ft 38.0 ft		129.0 ft 38.0 ft		139.0 ft 38.0 ft		
	0°	18°	0°	18°	0°	18°	0°	18°	
20	43.8								20
25	43.8		34.1						25
30	42.1		34.1		23.1		18.5		30
35	37.8	24.6	34.1		23.1		18.5		35
40	34.1	22.9	33.3	23.2	23.1		18.5		40
45	31.1	21.8	30.8	22.0	23.1	22.0	18.5		45
50	28.7	20.5	28.9	20.7	23.1	20.8	18.5	19.8	50
55	26.6	19.4	26.8	19.8	23.1	20.0	18.5	19.7	55
60	24.8	18.4	25.0	19.0	23.0	19.2	18.5	19.4	60
65	23.1	17.7	23.5	18.1	22.1	18.4	18.5	18.6	65
70	21.6	17.0	22.3	17.4	20.8	17.7	18.5	17.7	70
75	20.2	16.3	20.9	16.8	19.6	16.9	18.5	17.1	75
80	18.7	15.7	19.2	16.1	18.4	16.1	18.2	16.5	80
85	16.2	15.2	16.9	15.6	17.2	15.6	17.0	15.7	85
90	14.0	14.7	14.7	15.3	15.3	15.1	15.0	15.1	90
95	12.1	13.4	12.9	14.0	13.4	14.1	13.1	14.0	95
100	10.5	11.6	11.4	12.2	11.6	12.7	11.4	12.4	100
105	9.0	9.9	9.9	10.5	10.1	11.0	9.9	10.8	105
110	7.8	8.4	8.5	9.0	8.8	9.8	8.5	9.4	110
115			7.3	7.9	7.6	8.5	7.3	8.2	115
120			6.2	6.8	6.6	7.2	6.3	7.0	120
125			5.2		5.6	6.1	5.4	5.9	125
130			4.4		4.8	5.2	4.4	5.5	130
135					4.0	4.3	3.6	4.2	135
140					3.2	3.4	3.0	3.3	140
T1	1	1	1	1	0.9	0.9	1	1	T1
T2	0.5	0.5	0.5	0.5	0.9	0.9	1	1	T2
T3	0	0	0.5	0.5	0.9	0.9	1	1	T3

\*1000 lbs

Radius ft	Boom length (ft) + lattice extension length (ft)						Radius ft
	107.0 ft 62.0 ft		129.0 ft 62.0 ft		139.0 ft 62.0 ft		
	0°	18°	0°	18°	0°	18°	
30	19.0						30
35	19.0		13.8			11.2	35
40	19.0		13.8			11.2	40
45	19.0		13.8			11.2	45
50	19.0	15.5	13.8			11.2	50
55	19.0	14.9	13.8			11.2	55
60	18.7	14.4	13.9	13.5	11.2	12.1	60
65	17.7	13.7	13.8	13.0	11.2	12.1	65
70	16.7	13.2	13.8	12.5	11.2	12.1	70
75	15.8	12.7	13.8	11.9	11.2	11.8	75
80	14.9	12.1	13.7	11.3	11.2	11.3	80
85	13.9	11.5	13.2	10.8	11.2	10.8	85
90	13.4	11.0	12.7	19.4	11.2	10.4	90
95	12.8	10.6	12.2	10.1	11.2	10.1	95
100	12.0	10.2	11.7	9.8	11.2	9.4	100
105	11.2	9.9	11.0	9.4	11.0	9.4	105
110	10.0	9.5	10.0	8.9	9.8	8.9	110
115	8.8	9.1	8.8	8.5	8.6	8.7	115
120	7.8	8.5	7.8	8.3	7.5	8.4	120
125	7.0	7.8	7.0	8.1	6.3	7.8	125
130	6.0	6.8	6.0	7.2	5.6	6.8	130
135	5.2	5.9	5.2	6.3	4.7	5.9	135
140	4.4	5.0	4.4	5.4	3.9	5.2	140
145	3.6	4.1	3.6	4.7	3.2	4.5	145
150	3.0	3.4	3.0	3.9	2.7	3.6	150
155			2.4	3.2	2.2	2.9	155
160				2.6		2.4	160
T1	1	1	0.9	0.9	1	1	T1
T2	0.5	0.5	0.9	0.9	1	1	T2
T3	0.5	0.5	0.9	0.9	1	1	T3

# Weights / Working speeds



Axle	1	2	3	4	5	Total weight
lbs	26500	26500	26500	26500	26500	132500 incl. counterweight



Lifting capacity (tons)	Sheaves	Parts of line	Weight lbs
90	5	1 - 11	2200
55	3	1 - 7	1750
25	1	1 - 3	1100



Gear	1	2	3	4	5	R	Gradeability max.
On-road (mph)	8,0	13,3	21,0	31,0	43,0	3,75	
Off-road (mph)	4,8	7,8	12,3	17,9	24,8	2,50	58%
Tyres	16.00 R 25						



Drives	ininitely variable	Rope diameter / Rope length	Max. single line pull
Main hoist	0 - 394 ft/min single line	15 / 16" (23 mm) / 722 ft	20500 lbs
Auxiliary hoist	0 - 130 ft/min single line	15 / 16" (23 mm) / 722 ft	20500 lbs
Swing gear	0 - 2 min <sup>-1</sup>		
Boom elevation	approx. 65 seconds to reach + 83° boom angle		
Telescoping	approx. 210 seconds for boom length from 43 ft - 139 ft		





## Carrier

<b>Chassis:</b>	Special KRUPP 5-axle carrier, all-welded torsion-resistant box-type construction in high strength steel.
<b>Outriggers:</b>	4 hydraulic double-telescoping horizontal beams with vertical cylinders and outrigger pads. Independent horizontal and vertical movement control on each side of the chassis. Levelling device.
<b>Engine:</b>	Mercedes-Benz OM 424 Diesel, 12 cylinders, water-cooled, 309 kW (420 HP) at 2300 min <sup>-1</sup> , max. torque 1490 Nm at 1200 min <sup>-1</sup> . Tank capacity: 200 gal.
<b>Transmission:</b>	Allison 5-gear automatic powershift, transfer case, 2 speeds, with interaxle differential lock.
<b>Axles:</b>	5 axles. 1st, 2nd, 4th and 5th driven steering axles. 2nd, 4th and 5th planetary axles with transverse differential lock. 4th axle with interaxle differential lock.
<b>Suspension:</b>	All axles hydropneumatic with lock-out. All axles guided by longitudinal and transverse torsion bars. Dual level control. Suspension range: +4"/-8". Possible combinations for transverse slope, 2 × 9,5°.
<b>Tyres:</b>	10 tyres, 16.00 R 25. All axles with single tyres.
<b>Steering:</b>	ZF dual-circuit hydraulic power-assisted steering.
<b>Brakes:</b>	Service brake: pneumatic dual-circuit, acting on all wheels. Air-dryer. Permanent brake: retarder integrated with Allison automatic transmission. Hand brake: pneumatically operated spring-loaded brake, acting on 2nd to 5th axle.
<b>Driver's cab:</b>	<b>Aluminium</b> , 3-man-design, safety glass, driver's seat with hydraulic suspension, engine hot-water heating. Complete instrumentation and driving controls.
<b>Electrical system:</b>	Three-phase generator 28 V / 55 A, 2 batteries 12 V / 170 Ah. Lighting system and signals.

## Superstructure

<b>Frame:</b>	KRUPP-made, torsion-resistant, welded construction in high strength steel.
<b>Engine:</b>	Mercedes-Benz OM 366 LA Diesel, 6 cylinders, water-cooled, 121 kW (164 HP) at 2300 min <sup>-1</sup> , max. torque 575 Nm at 1400 min <sup>-1</sup> . Tank capacity: 90 gal.
<b>Hydraulic system:</b>	3 separate circuits: 1 axial piston double pump, 1 triple gear pump with cumulative flow control. Tank capacity: 350 gal. hydraulic oil
<b>Control system:</b>	Infinite variation of all crane movements by hydraulic pilot control and control lever with dead-man position.
<b>Main hoist:</b>	Axial piston motor with infinitely variable speed and displacement control, planetary gear and automatic brake.
<b>Boom elevation:</b>	1 cylinder with safety holding valve, boom angle from -1,6° to +83°.
<b>Swing gear:</b>	Axial piston fixed displacement motor with planetary gear, holding brake and service brake.
<b>Operator's cab:</b>	<b>Aluminium</b> , full vision, safety glass, fully adjustable operator's seat with hydraulic suspension. Armrest-integrated crane controls. Clearly arranged engine instrumentation and crane operating controls. Hot-water heating system.
<b>Safety installations:</b>	Hoist and lowering limit switch, pipe break safety valves, pressure relief valves.
<b>Telescoping boom:</b>	Welded construction in high strength steel, 1 pivot basic section, 3 telescopic sections. Total length 139 ft. All-hydraulic extension under partial load.
<b>Electrical system:</b>	Three-phase generator 28 V / 55 A, 2 batteries 12 V / 143 Ah.

## Additional equipment

<b>Drive:</b>	10 × 8
<b>Lattice jib:</b>	Swing-away lattice 38 ft to 62 ft, stowing alongside boom.
<b>Auxiliary hoist:</b>	2nd hoisting gear
<b>Driver's cab:</b>	Stationary heating system with engine preheater, bunk, 3rd seat.
<b>Load moment limiter:</b>	Electronic load moment safety device (EKS 83) with automatic cut-out and digital display for actual and admissible load, radius and various working conditions.

Further options available upon request.



# Notes

---

---

---

---

---

---





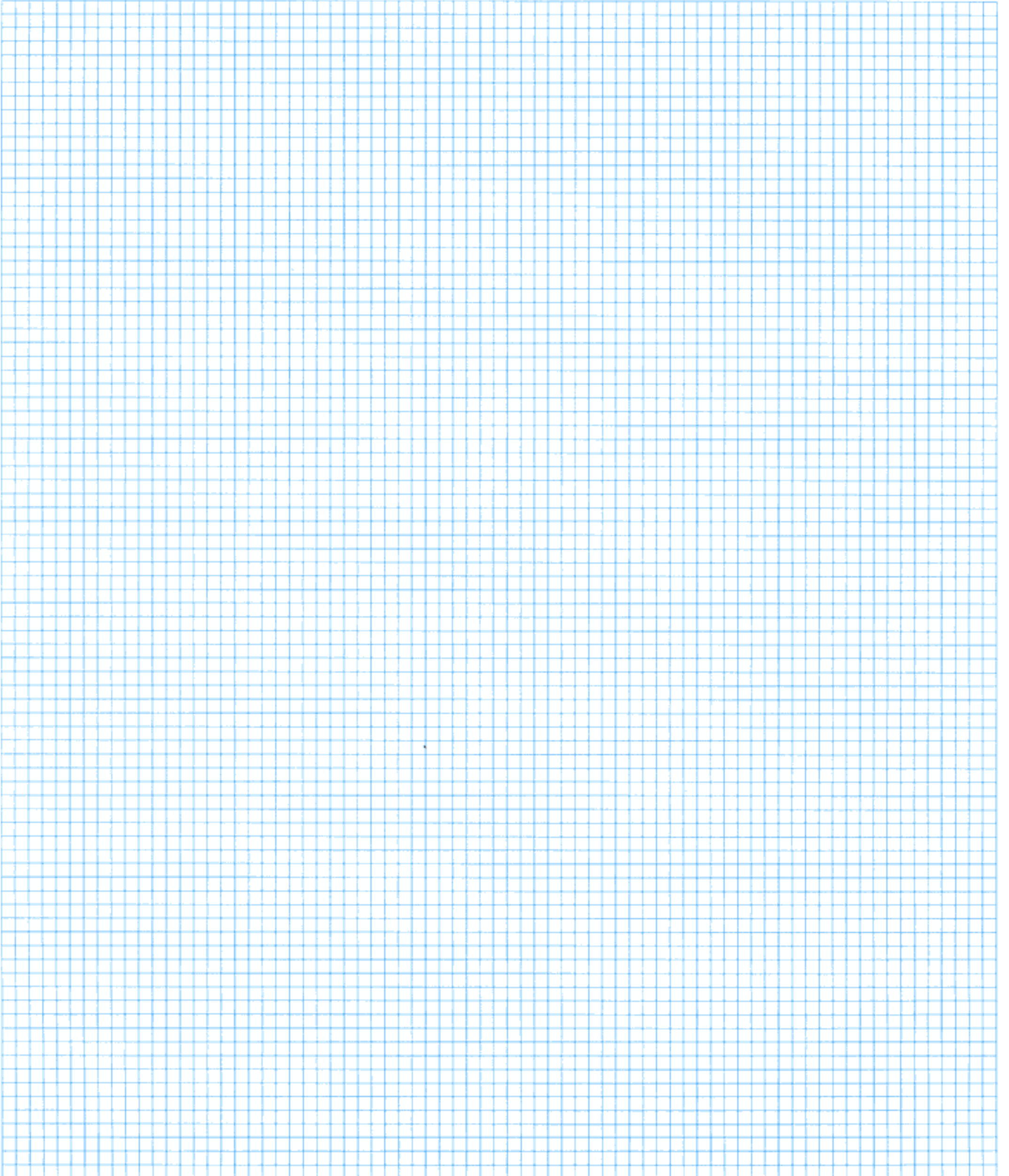









---

---



# KRUPP Hydraulic Mobile Cranes

## Product Range

Truck Cranes		Max. lifting capacity	Max. hook height
KMK 5120		120 ton	220 ft*
KMK 6250		250 ton	320 ft*
KMK 8450		450 ton	365 ft*
KMK 8500		500 ton	390 ft*
KMK 11000		1000 ton	440 ft*
All-Terrain Cranes			
KMK 2025		25 ton	122 ft
KMK 2035		35 ton	129 ft
KMK 3045		45 ton	148 ft
KMK 4055		55 ton	148 ft
KMK 4065		65 ton	167 ft
KMK 4080		80 ton	178 ft
KMK 5130		130 ton	201 ft
KMK 6165		165 ton	296 ft*
KMK 6275		275 ton	350 ft*

\* incl. power luffing jib

**Krupp Industries Inc.**  
 1370 Washington Pike  
 Bridgeville, Pa. 15017/USA  
 Telephone (412) 257-5680  
 Telefax (412) 221-7684

**Krupp Canada Inc.**  
 98 Columbus  
 Pointe Claire, Que. H9R 4K4  
 Telephone (514) 694-4740  
 Telefax (514) 694-6280

Subject to technical modifications without notice